

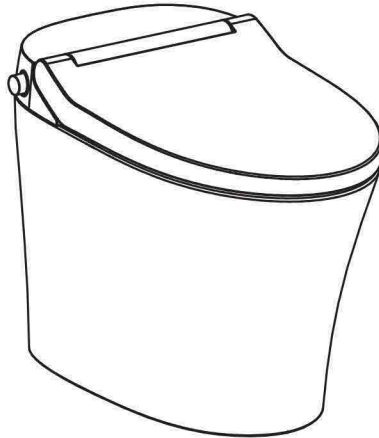

Thank you for choosing our products !



ST09 02

Smart Toilet Manual

Please read the manual carefully before installing and using.*

These photos are for reference only, please refer to the actual products!

Contents

Before use

Safety precautions	1
Overall sketch	6
Function introduction	7

Installation guide

Toilet installation	8
Remote control bracket installation	11

Operation

Operation introduction	12
Preparation	12
Product use	13
Troubleshooting	19
Cleaning and Maintenance	20



Appendix

Product specification	24
Packing list	25



Safety precautions



Please read the 'Safety Precautions' section carefully before use. All listed precautions are important for your safety and must be followed.

Sign and meaning

	Warning Improper operation due to ignoring the instructions may result in death or injury.
	Notice Improper operation due to ignoring the instructions may result in personal injury and property damage.

The following signs indicate important safety precautions.

Sign	meaning
	Represents 'not allowed' or 'forbidden'
	Represents 'enforced' or 'required'

 WARNING	
	Do not touch the electrical outlet with wet hands. <ul style="list-style-type: none">• Doing so may cause electric shock.
	Do not pour water, hot water, or detergent on the top of the toilet or electrical outlet. <ul style="list-style-type: none">• This may cause fire, electric shock, overheating, or short circuit.• It may also lead to injury and indoor water seepage due to damage to the product.
	Never attempt to disassemble, repair, or alter the product yourself. <ul style="list-style-type: none">• Doing so may cause fire, electric shock, overheating, or short circuit.
	Do not install the toilet in a car, ship, or any other moving object. <ul style="list-style-type: none">• This may result in fire, electric shock, short circuit, or malfunction.• The ceramic, seat, and main parts may also be damaged from falling.
	Stop using the product if it malfunctions. <ul style="list-style-type: none">• Under the following conditions, disconnect the power supply and turn off the water angle valve:<ul style="list-style-type: none">–Water leakage from the pipe or inside the product–Cracks or damage to the product–Unusual sounds or smells–Smoke–Unusual heating–Blockages–Falling out of the cushion• Continuing to use the toilet despite these faults may result in fire, electric shock, overheating, short circuit, injury, and indoor water seepage.

Do not use seawater or any water other than tap water or potable well water (underground water).

- Doing so may cause skin irritation or damage to the product.

Do not touch the electrical plug during a thunderstorm.

- This may result in electric shock.

Do not allow the water inlet soft pipe to come into contact with the electrical plug or outlet.

- Moisture condensation may cause fire, electric shock, overheating, or short circuit.

Do not damage or destroy the power cable or plug.

- Avoid striking, yanking, twisting, excessively bending, or placing heavy objects on the cords. Do not bind or pinch the cords.

- Damaged cords can cause fire, electric shock, overheating, or short circuit.

Do not use a loose or faulty electrical outlet.

- This may result in fire or short circuit.

Use the electrical outlet and wiring according to specified guidelines.

- Incorrect use may cause fire due to improper appliance wiring.

Do not insert fingers or objects into the warm air outlet.

- Avoid placing objects or clothes on or covering the air outlet.

- This may cause burns, electric shock, or damage to the accessories.

Keep cigarettes and other open flames away from the product.

- This may cause a fire.



Pay Attention to Low-Temperature Scalding

- Improper use of the warm seat may cause low-temperature scalding.
- If sitting for an extended period, please turn the temperature setting to the "off" position. Set the seat temperature to "off" and the warm air dry temperature to "low" in the following situations:

–For children and elderly individuals who cannot adjust the temperature themselves

–For patients and disabled individuals who may have behavioral issues.

–For people taking medications with sedative effects (e.g., hypnotics, cold remedies) or those who are intoxicated, overly tired, or drowsy.

This is an electrical product; do not install it in a location prone to moisture or high humidity.

- If installed in a bathroom, also install a ventilator to ensure proper ventilation.
- Failure to do so may cause fire or electric shock.

The product must be connected to a cold water supply.

- Failure to connect to the cold water supply may cause burns or product malfunction.

The product must be properly grounded.

- If not properly grounded, it may cause electric shock.
- Ensure that grounding resistance is below 100 ohms, the earth wire is at least 1.5 mm in cross-section, and made of copper.
- Please have a qualified installation company handle the grounding.



Confirm Grounding of the Electrical Outlet

- Ensure the electrical outlet is properly grounded.
- Failure to do so may cause electric shock due to faults or short circuits.

The Power Outlet Must Follow These Rules:

- Failure to comply may result in fire or electric shock.
 - a. Use a high-sensitivity, fast-responding leakage switch (rated at 15mA or below) or an insulating transformer (1.5kVA-3kVA) to protect the outlet circuit.
 - b. Ensure the outlet installation location is away from the bathtub.
- Confirm that the above wiring guidelines (a and b) are completed, or have a qualified engineering contractor perform the installation.

Ensure the Electrical Plug is Firmly Inserted into the Outlet

- Failure to do so may cause fire, overheating, or short circuits.

When Removing the Plug, Hold the Plug Itself, Not the Wire

- Do not pull the plug by the wire.
- Pulling by the wire may cause damage, leading to fire or overheating.

**If the Power Cord is Damaged, Have it Replaced by a Professional**

- Contact the company's maintenance department or a similar service for replacement.
- This prevents potential hazards.

Turn Off the Power During Maintenance or Inspection

- Failure to do so may result in electric shock or damage to components.
- Note: This does not apply to nozzle cleaning.

Disabled Individuals or Those Lacking Experience (Including Children) Should be Supervised While Using This Product

- Supervision is required to prevent scalding, electric shock, fire, or injury.

Do Not Allow Children to Play with This Product

- Unsupervised use by children may cause scalding, electric shock, fire, or injury.

Do Not Dispose of Lighted Cigarettes or Flaming Materials in the Toilet

- Doing so may cause fire.

Do Not Use the Product if You Have a Pacemaker or Other Sensitive Medical Equipment

- The strong magnets inside the product may interfere with pacemakers and other medical devices.



NOTICE

Do Not Use the Product if it is Loose

- The toilet and seat may separate and fall, potentially causing injury.

Avoid Touching Broken Areas

- Touching broken parts may cause injury. Replace damaged parts as soon as possible.

Do Not Apply Force, Place Heavy Objects, or Stand on the Product

- Doing so may cause damage, falling, or injury.
- It could also result in indoor water seepage if the product is damaged.

Do Not Pull the Product by the Seat or Cover

- Do not open the seat or cover when objects are on the product.
- This could cause the main body to fall, leading to injury.

Use Only Neutral Kitchen Detergent for Cleaning Plastic Parts and the Water Inlet Hose

- Avoid using bathroom detergents, household cleaners, gasoline, banana oil, cleaning powders, or nylon brushes.
- Using inappropriate cleaners may damage the plastic parts, cause cracks, or result in injury due to malfunction.
- It could also lead to water leakage from a damaged hose.

To Prevent Sudden Water Leakage, Do Not Remove the Water Inlet Filter While the Angle Valve is Open

- Refer to the cleaning instructions for the water inlet filter.
- Removing the filter while the valve is open may cause water to spray out.

Do Not Crush or Bend the Water Inlet Hose

- Crushing or bending the hose may cause water leakage.

Use Only the New Hose Provided in the Accessory Box

- The old hose is not recyclable and may cause water leakage.

Do Not Pour Hot Water into the Toilet

- Pouring hot water may damage the toilet and cause injury or indoor water seepage.

Do Not Flush Large Amounts of Toilet Paper or Other Items Except Sewage and Small Amounts of Toilet Paper

- Flushing inappropriate items may cause damage to the toilet and result in injury or indoor water seepage.

Do Not Lean on the Toilet Cover While Using It

- Leaning on the cover may damage it.





NOTICE

Close the Angle Valve if Water is Leaking

- To prevent water damage, always close the angle valve if you notice any leaks.

Prevent Pipe or Hose Damage in Freezing Conditions

- When room temperature is below 0°C, adopt anti-freezing measures to prevent damage to pipes or soft hoses.
- Frozen water inlet hoses can damage the main body or piping, leading to water leakage.
- Ensure proper room temperature to avoid freezing.

Drain the Inlet Soft Hose and Cut the Power if Not in Use for an Extended Period

- Before leaving the product unused for a long time, drain the inlet soft hose and disconnect the power supply.
- When using the product again, open the angle valve and let water flow first.
- Failure to do so may cause skin irritation due to poor water quality.
- Keeping the power connected can lead to overheating or fire hazards.



Ensure the Filter is Properly Installed

- Confirm that the filter is screwed in tightly during installation.
- A loose filter may result in water leakage.

Address Blockages in the Toilet Drain Outlet Properly

- If the drain outlet is blocked, cut off the power before cleaning the obstruction.
- This will prevent sewage overflow and indoor water seepage caused by the auto flush function.
- Use professional tools available in the market to clear blockages.

Flush the Toilet After Urination

- Flushing after urination helps prevent difficulty in cleaning the toilet, drain blockages, or sewage overflow, which can lead to indoor water seepage.

Clean Spills on the Floor Promptly

- Use a dry towel to clean up urine, detergent, water, and other spills on the floor.
- This prevents dirt buildup or floor corrosion.



NOTICE

This bidet must be connected to a GFCI outlet and should not be used with an extension cord

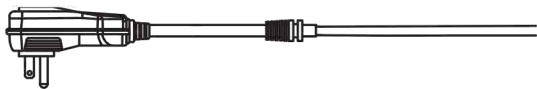

Overall Sketch

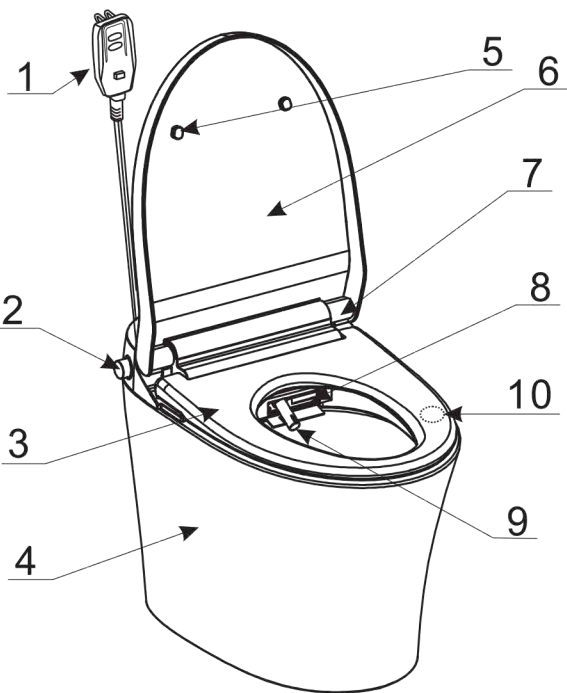

- 1 Power plug (Electric Leakage Protection)
- 2 Side knob
- 3 Heated seat
- 4 Toilet bowl
- 5 Cushion pad
- 6 Toilet lid
- 7 Damper
- 8 Dryer outlet
- 9 Nozzle
- 10 Sensing area

Remote control

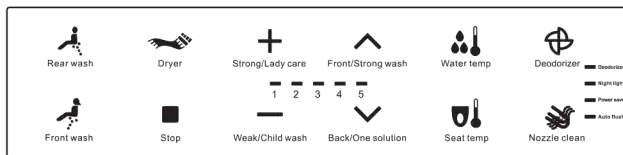

NOTICE

The contents of this manual, including but not limited to product materials, processes, and functional characteristics, may differ from the actual product due to process improvements or product upgrades. Please refer to the actual product for the most accurate information.

Functions introductions

Function	Introduction
Rear Wash	Cleans the rear with a back-and-forth nozzle movement
Rear Oscillating Wash	Provides rear cleansing with an oscillating nozzle
Front Wash	Delivers a gentle front spray
Front Oscillating Wash	Cleans front with an oscillating nozzle
Child Wash	Gentle, warm water spray for children
One solution	Auto clean, flush and dry
Strong Wash	Powerful cleanse with a large amount of water
Lady Care	Special cleaning for female needs
Nozzle Position Adjustment	Adjusts nozzle position for optimal washing
Temperature Adjustment	Sets seat and water temperature
Water Pressure Adjustment	Controls cleaning water pressure
Seat Sensor	Activates functions when sitting
Drying	Provides drying with a movable air outlet
Drying Intensity	Controls warm air temperature for drying
Nozzle Self-Clean	Automatically cleans the nozzle
Smart Remote Control	Operates functions via remote
Deodorizer	Removes odors
Energy Saving	Reduces electricity usage
Night Light	Provides illumination in low light
Soft Close	Gently closes the seat and cover
Auto Flush	Flushing activates automatically after use
Power Switch	Turns the power on and off
Flush Even if Power Off	Flushing works even without power
Ceramic Bowl Pre-Wet	Pre-wets the bowl before use
Foot sensor flush*	Activates flush with foot sensor
UV Sterilization	Uses UV light for sterilization (model-dependent)

Note: Features may vary by model

Installation method

◆ Toilet installation ◆

※ Supply stop installation

1. Turn on the water supply and flush for 1 minute. This removes any debris that might damage the toilet.
2. Turn off the water supply and remove the old supply stop.
3. Wrap sealing tape around the end of the water supply pipe (1/2" NPT male thread) This ensures a proper seal. Screw the adapter onto the pipe, aligning it with the arrow as shown.
4. Apply Teflon tape to the fitting. Start wrapping at the end of the fitting to prevent seizing. Tighten the threaded joint 1-2 turns beyond finger tight, being careful not to over-tighten.

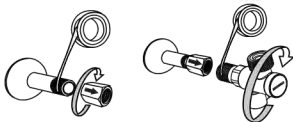

Installation in North America

Installation in other regions

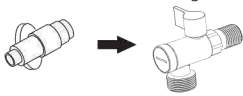

1. Remove the angle valve.
2. Replace the smart toilet angle valve.

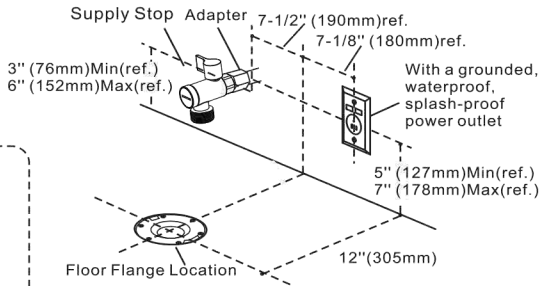

※ Confirm water flow

1. Install a matching hose.
 - Direct the hose to a bucket with a capacity of 3 gallons (11.4L) or more. If a matching hose is unavailable, cover the supply stop outlet with a cloth and place the bucket under the valve.
2. Turn on the supply stop
 - Ensure that at least 1 gallon of water flows out within 10 seconds.
3. If water pressure is low,
 - Remove the flow regulator from the supply stop or use a booster pump to increase the pressure.
4. Close the supply stop
 - Remove the installed hose.

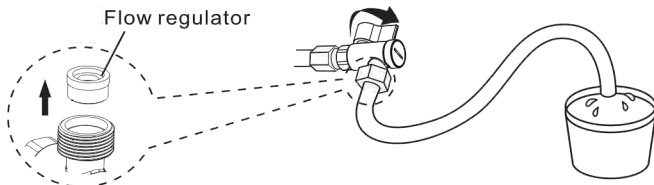

※ Install the toilet

Note: If the distance between the sewage outlet and the wall surface is less than 12" (305mm), the toilet lid may touch the wall surface when opened.

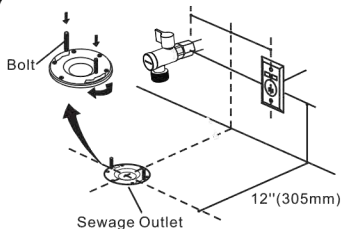

For new installations, toilet flanges must be installed. Install flange bolts accordingly

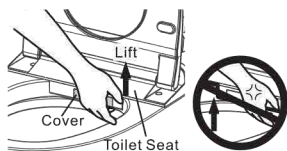

Lift the toilet seat-lid assembly from the interior, back right, being careful not to pull excessively

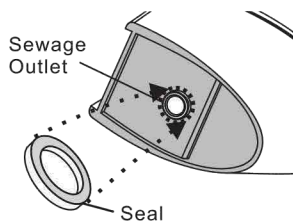

Install sealing ring under the toilet

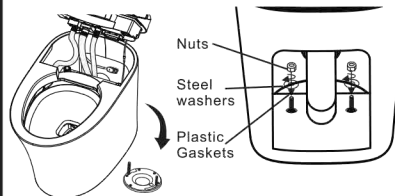

Install the toilet onto the flange, ensuring the bolts align with the holes in the toilet. Use a wrench to tighten the nuts and other accessories onto the fixing bolts.

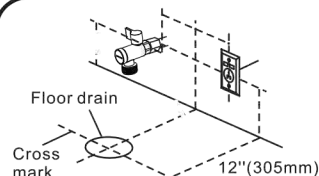

Mark a cross on the floor drain, clean the floor, and dry any remaining water

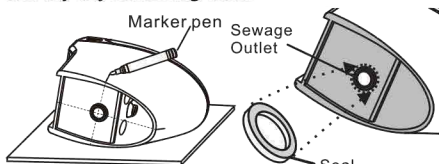

Gently flip the toilet and place it on a pre-prepared foam board. Center the sewage outlet of the ceramic body, mark the sides of the toilet bowl perpendicular to its bottom plane. Mark the center of the front of the toilet bowl perpendicular to the ground. Finally, install a sealing ring under the toilet.

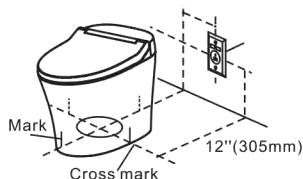

Lift the toilet, align the marks on the toilet bowl with the cross marks on the ground, and lower the toilet slowly until the marks coincide. Press down on the toilet to ensure the sealing ring gasket makes full contact with the ground and forms a tight seal. **Note:** Once the marks are aligned, avoid moving or shaking the toilet, as this could damage the seal and lead to water leakage.

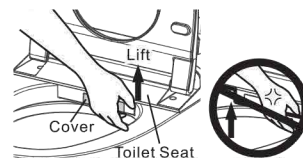

Lift the toilet seat-lid assembly from the interior, back right. **Note:** Avoid excessive pulling of the cover during the lift.

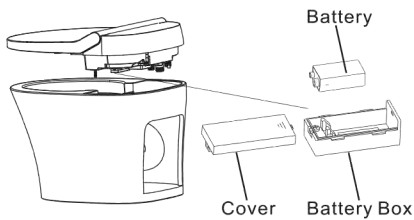

1. Carefully remove the battery case cover.
2. Install the battery and slide the cover back onto the battery box.
3. Press the control dial on the side to ensure normal flushing operation.

Note:

- Use alkaline batteries.
- The battery maintains the flushing function during a power failure.
- Do not dispose of used batteries in the trash; please recycle them at your local battery collection center.

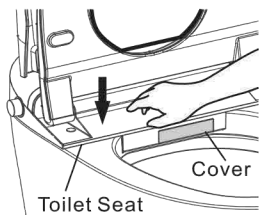
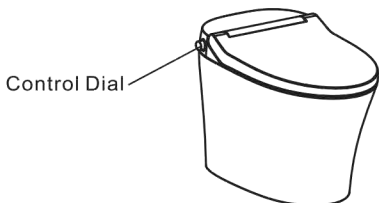

Reinstall the toilet seat-lid assembly to complete the installation.

Note: Avoid applying excessive force when reattaching the assembly.

※ Connect the water inlet pipe

Connect the water inlet hose to the supply stop.

Note:

1. Tighten by hand, then turn the nut 1/4 turn with a wrench.
2. Open the supply stop.
3. Check for leaks.
4. Apply silicone sealant around the base of the toilet and allow it to dry for 24 hours.

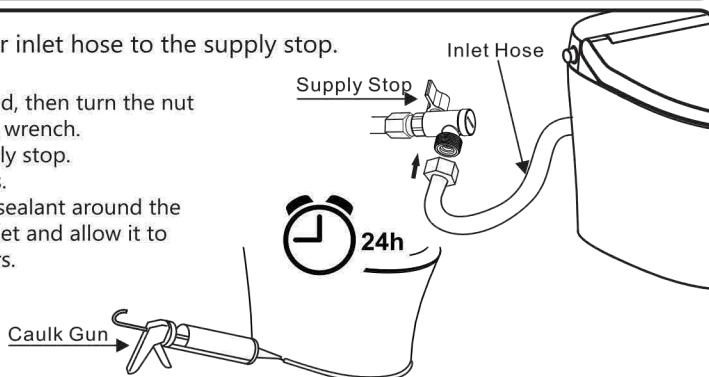

◆ Install the remote controller ◆

■ The following picture shows the installation method

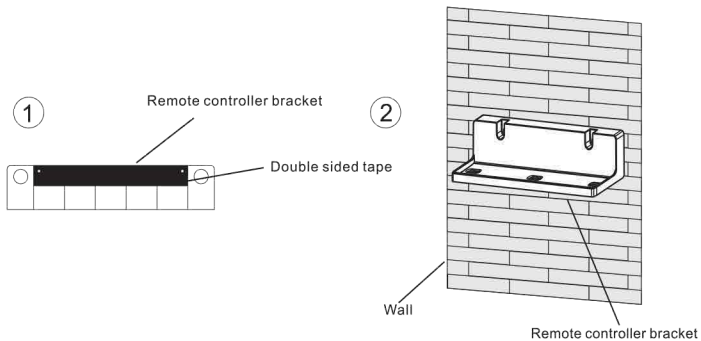

Tear off the paper from the double-sided tape on the back of the bracket and stick the bracket onto the wall.

Notice: Clean the installation area before applying. Press the tape firmly and evenly. Wait 15 minutes before use.

Operation

◆ Operation introduction

* The design of this product is primarily controlled by remote control, with additional support from a side knob control.

* The following section provides a functional introduction.

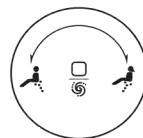
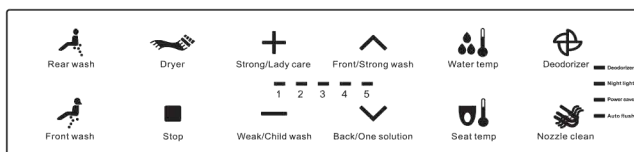

Remote control

Side knob

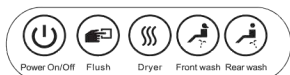

Control panel

Indicator light

* Indicator lights and LED display panels may vary according to specific model configurations; please refer to the actual model for details

* The following section provides a functional introduction.

◆ Preparation

1. Open the angle valve

Switch to this position

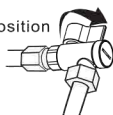

2. Confirm power plug is well plugged into the electric outlet and the indicator light is on.

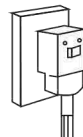

3. After the machine is powered on and initialized, it defaults to the last used settings. Parameters such as water temperature, seat temperature, auto deodorization, and auto flushing are automatically restored to their settings before power was turned off.

4. If it is not powered on, press the power button on the side knob to power it on.

◆ How to use

Sit on the seat

- The seat sensor reacts automatically when you sit on it.
- Water is released to pre-wet the inner ceramic bowl.
- Deodorization starts automatically when the deodorizer activates.

Water pressure adjustment

Choose from 4 levels to adjust the water pressure for comfort by pressing



Strong/Lady care Weak/Child wash

Stop

- Stop the current cleaning operation. If the stop button is not pressed, rear washing or front washing will stop automatically after 2 minutes.
- Long press this button for 3 seconds to turn off.

Nozzle position adjustment

Choose from 5 positions to adjust the nozzle for effective cleaning by

pressing  

Front/Strong wash Back/One solution

Notice: Nozzle position adjustment is unavailable during oscillating cleaning.

Reminder

The number below the remote control indicator is for reference only in functional instructions. The actual remote does not display this number.

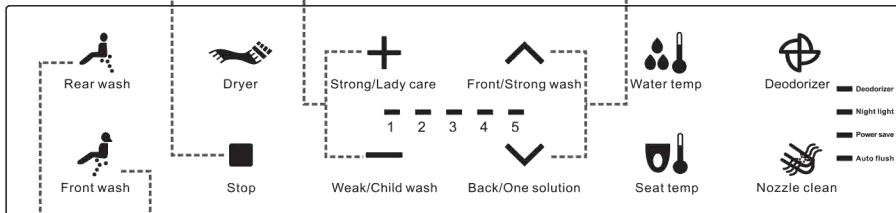

Rear wash

Press  to extend the nozzle for rear washing.

Press again for rear oscillating cleansing. Indicator #1 blinks on the remote control; the nozzle swings back and forth.

Press again to stop oscillating cleansing and switch back to rear wash.

Front wash

Press  to extend the nozzle for front washing.

Press again for front oscillating cleansing. Indicator #1 blinks on the remote control; the nozzle swings back and forth.

Press again to stop oscillating cleansing and switch back to front wash.



Deodorizer

Press this button to start deodorizing; the indicator on the remote control will light up. Press again to close.

Nozzle clean

Press  to enter nozzle cleaning mode; water flows out for cleaning.
* Nozzle cleaning is effective.
* The nozzle automatically cleans its periphery before rear wash and front wash.

Warm air temp adjustment

Choose from 4 levels to adjust the warm air temperature by pressing  
Strong/Lady care Weak/Child wash

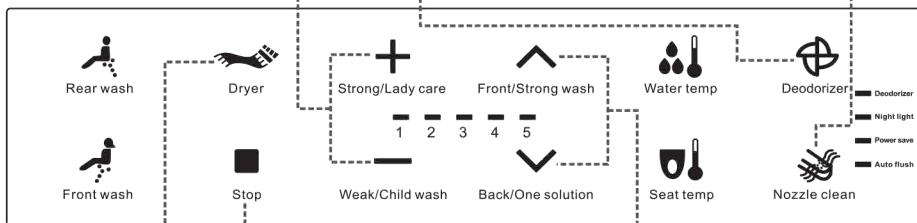

Dryer

- Press to start warm air drying.
- Press again for oscillating air drying; the dryer swings back and forth.
- Press again to stop.

Note: When auto flush is activated, the smart toilet will flush first before drying.

Dryer position adjustment

Choose from 5 positions to adjust the dryer position by pressing  
Front/Strong wash Back/One solution

Notice:

Dryer position adjustment is unavailable during oscillating drying.

Reminder

Deodorizer turns off during drying. It automatically activates again after drying finishes and continues for 1.5 minutes when the seat is vacant.

Stop

Turn off the drying function. The warm air will stop automatically after running for 4 minutes.

Lady care

Press to enter lady care mode in idle mode. The nozzle extends for work, water temperature is set to the highest level (39°C), water pressure is set to level 2, and the cleaning position is preset. Note: Water temperature and pressure are not adjustable in this mode. Automatic end after cleaning

for 2 mins. Press  to end.

Water temp

Press to enter water temperature adjustment mode.

Choose from 4 levels: normal temperature, level 1 (33°C), level 2 (36°C), and level 3 (39°C).



Rear wash



Dryer



Strong/Lady care



Front/Strong wash



Water temp



Deodorizer



Front wash



Stop



Weak/Child wash



Back/One solution



Seat temp



Nozzle clean

 Deodorizer

 Night light

 Power save

 Auto flush

Child wash

Press to enter child wash mode in idle mode. The nozzle extends for work with the nozzle position set to front (level 5), minimum water pressure (level 1), and mild grade water temperature (36°C) After washing 30s to end or press  to end.

Note: Cleaning position, water pressure, and water temperature are not adjustable in this mode.

Seat temp

Press to enter seat temperature adjustment mode. Choose from 4 levels: normal temperature, level 1 (33°C), level 2 (36°C), and level 3 (39°C).

Attention: To prevent low-temperature scalding, the toilet seat automatically lowers below 35°C after sitting for 10 minutes.

One solution

Press to start in idle mode: rear wash for 40 seconds → oscillating wash for 20 seconds → warm air drying for 2 minutes → stop.

In this mode press  to end.

Reminder

In idle mode, rear wash, front wash, dryer, flush, etc., are not operational.

Child wash and one solution, strong wash, and lady care must be enabled in idle mode

Strong wash

Press to enter strong washing mode in idle mode. The nozzle extends for work and the highest water pressure is applied.

2mins to end. Press  to end.

Power save/off

Press this button. The corresponding indicator blinks on the remote control in standby mode. After leaving the seat for 1.5 minutes, the unit enters power saving mode. In this mode, the seat temperature is maintained at 25°C, and previous settings are automatically restored upon next use. To shut down, press and hold for 3 seconds.

Night light

Press this button to turn on the light; press again to turn it off. The corresponding light on the right will simultaneously turn on or off. This action is repeatable for switching.

Flush/Auto flush

- Press to flush the toilet; the corresponding indicator blinks on the remote control.
- Long press for 3 seconds to start auto-flush. After leaving the seat for 5 seconds, the toilet flushes automatically.
- Long press again to deactivate.

Attention: Auto-flushing does not operate when people sit on the seat and flush the toilet with the remote control or side button.

Power save/Off Night light Flush/Auto flush



Rear wash



Dryer



Strong/Lady care



Front/Strong wash



Water temp



Deodorizer



Front wash



Stop

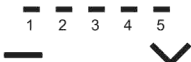

Weak/Child wash



Back/One solution



Seat temp



Nozzle clean



Reminder

After the machine completes its power-on initialization, it returns to default settings: power-on state, water temperature, seat temperature, automatic deodorization, automatic flushing, and other parameters set before power-off.

Reminder

Working Mode Distinction

- Operation Mode: Engaged in rear wash, front wash, drying, flushing, nozzle cleaning, etc.
- Idle Mode: Awaiting instructions in non-operational states.
- Standby Mode: Activated by pressing the power button on the remote control or side button, resulting in the lowest power consumption state.

Product side knob

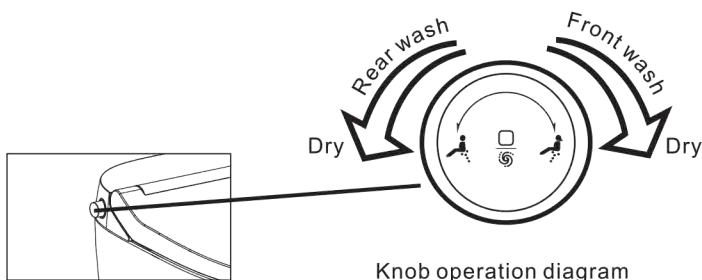

1. In the off state, the knob indicator is not lit. Rotating it forward/backward or pressing it starts actions. The product enters idle mode automatically, indicated by a light pink glow, resembling a breathing light effect.
2. In idle and off-seat modes, functions do not activate on forward or backward knob rotations, indicated by a light pink glow.
3. When a person sits on the seat, the product activates. Rotating the knob forward initiates automatic front wash. The first wash lasts 1 minute, followed by a 2-minute warm air dry. Rotating forward again during front wash stops washing and starts warm air drying, with the indicator light turning pink for front wash and red for warm air dry.
4. When a person sits on the seat, rotating the knob backward initiates automatic rear wash. The first wash lasts 1 minute, followed by a 2-minute warm air dry. Rotating backward again during rear wash stops washing and starts warm air drying, with the indicator light turning blue for rear wash and red for warm air dry.
5. When a person sits on the seat in rear wash/front wash/dry working state, pressing the knob stops all three functions, entering idle mode with a light pink indicator.
6. In idle or power-off mode, pressing the knob initiates flushing. During flushing in idle mode, the indicator light is light red.
7. Press the knob twice continuously to activate water-saving mode (small flush).
8. In the powered-on state, long press the knob for 3 seconds to turn it off. The indicator light turns off.

Buzzer

Buzzer:

- Buzz once: Seat occupied; all functions available.
- Buzz twice: Seat vacant; some functions available.
- Buzz three times or more: Product fault.

Reminder: The buzzer operates only during remote controller or side button operations or during initialization.

Control panel



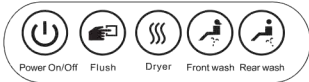

The product is primarily controlled using the remote control. The control panel only offers basic functions, as shown in the picture below:



- Key operations are consistent with the remote control. Refer to remote control usage for details.
- Water temperature and seat temperature settings remain unchanged after using the side buttons.
- During power cuts, press  to flush.

Indicator light



Power		Constantly lit: Power is on. Flashes: Control panel fault.
Water temperature		Enter water temperature setting. Adjust between: Normal, 33°C, 36°C, 39°C. Normal: No indicator light. Other settings: Indicator lights up. Flashing indicates water heater failure.
Seat temperature		Enter seat temperature setting. Adjust between: Normal, 33°C, 36°C, 39°C. Normal: No indicator light. Other settings: Indicator lights up. Flashing indicates seat heater failure.
Seat sensor		Activates when seated; indicator lights up. Proximity sensor: Seat indicator flashes for 3s.
Power saving		Automatic function on; indicator lights up. Enters energy saving mode: Only power and power save indicators are lit.

*Foot sensor flush

Operating Instructions: When your foot crosses the sensor switch at the bottom, the flushing function will be activated. This function is limited to certain models. Please refer to the product function table for details.
Reminder: This function does not operate while seated.

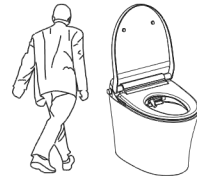

*UV sterilization

When the human body leaves the seat for 15 seconds, the UV sterilization function activates automatically and sterilizes the nozzle for 3 minutes. It restarts every 4 hours.

Note: This function varies with different model configurations. The UV sterilization starts with a 3-second low-light flash. Avoid direct eye exposure during operation to prevent permanent eye damage.

Remote control code matching

If a user has more than two items of the same brand of smart toilet, there may be interference when using the remote control. In this case, use the remote control code matching function to ensure each remote control is unique to its toilet.

Follow these steps:

1. Unplug the smart toilet from power.
2. Simultaneously press the "weak" and "back" buttons until the indicator light blinks continuously.
3. Plug the smart toilet back in within 5 seconds.
4. The remote control indicator light will stop blinking when the code matching is complete.

Notice: The remote control matching process times out after 10 seconds and will stop automatically if it exceeds this time

◆ Troubleshooting ◆

SITUATION	REASON	PROCESS
No power	The electrical outlet is not connect to power supply or the plug is not insert to the bottom	Check if the electrical outlet is connected to the power supply; press the reset key on the plug
No water comes out while cleaning	Low water pressure	Raise the water pressure
	Water inlet filter is blocked	Remount and clean the filter according to the instructions
Cleansing water in not warm enough	Water temp setting is incorrect	Readjust the setting
Seat does not heat	Seat temp setting is incorrect or the product is in power saving mode	Readjust the setting
Seat and cover are loose	Fixed bolts are loose	Tighten the bolts
Remote controller failure	Battery is dead	Replace the battery
No response when pressing the key	Key malfunction	Reboot or contact customer support
Water leakage	Shutoff valve, water supply hose, or water separator are not properly connected	Reconnect them

Cleaning and Maintenance

• Toilet bowl cleaning

- ◆ Please make sure the electrical plug is taken out
- Before cleaning, ensure the electrical plug is removed.
- Use a damp soft cloth to wipe the toilet shelf and seat.
- Clean dirt promptly; for stubborn stains, use a neutral detergent if necessary.

• Nozzle Cleaning and Maintenance

Press "nozzle clean" to extend the nozzle for automatic washing, then use a brush to clean it.

Attention: Do not use a steel brush for cleaning.

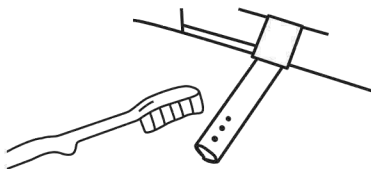

• Cleaning the filter

When the water pressure is too low or insufficient, please clean the filter.

1 Close the angle valve and stop water supply

Notice: Do not remove the filter without closing the angle valve.
----Otherwise water will spray out.

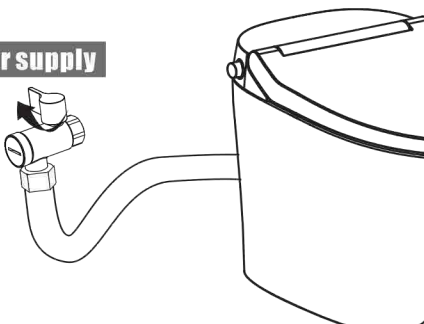

2

Remove the filter

Unscrew the cover of the filter by straight screwdriver and then pull out the cover as below:

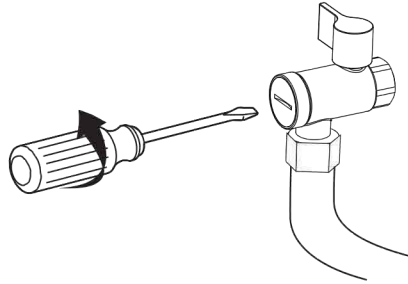

3

Clean the filter

- Remove the filter and clean it thoroughly.
- Flush off dirt or clean the filter using a toothbrush.

Note: Do not use any cleaning agents; clean with water only.
Avoid crushing the filter to prevent distortion.

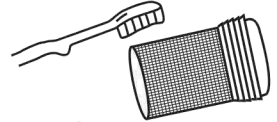

4

Reattach the filter

Reinstall the filter following the removal sequence.

Notice: Open the shutoff valve after installation and ensure there is no water leakage.

• Replace the remote control battery

When the battery is low, the remote controller may become insensitive or malfunction. Replace the battery at this point..

※ Attention

- Ensure the battery's positive and negative poles are correctly aligned; the compression spring should protrude from the negative pole.
- Do not mix new and old batteries;
- Please use alkaline batteries.

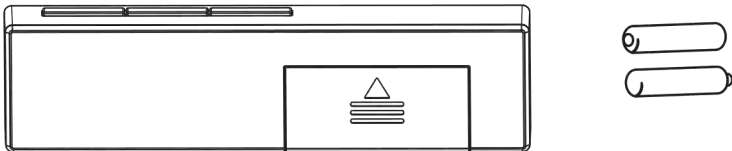

● Replace back up battery

Steps

1. Pull out the power plug
2. Lift the toilet seat lid
3. Remove the battery cover
4. Insert the battery in the correct position
5. Press the flush button to ensure it functions properly
6. Replace the cover and secure the toilet seat lid

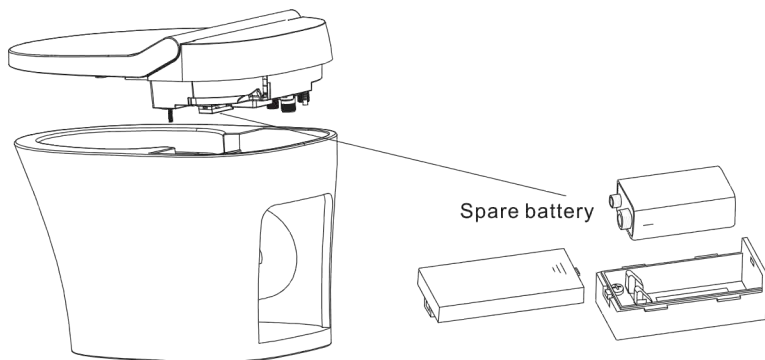

※ Notice

1. The backup battery must be a 9V alkaline battery; do not use carbon or other types.
2. Low battery or improper installation may cause abnormal flushing, including malfunction during power outage.
3. We recommend checking and replacing the backup battery every two years.
4. Please replace used batteries and recycle them properly.

Appendix

◆ Product specification ◆

Ambient temp range		4°C-40°C	
Inlet water temp range		5°C-35°C	
Rated voltage		<input type="checkbox"/> 220V~ 50Hz	<input type="checkbox"/> 120V~ 60Hz
Rated power		1200W	1200W
Power cord length		1.5m (0.85m for North America)	
Cleansing device	Water pressure range	0.14MPa-0.75MPa(Flow volume is no less than 18L/min)	
	Water pressure adjustment	Adjustable in 4 levels	
	Water temp adjustment	Adjustable in 4 levels: Room temp, 33°C, 36°C, 39°C	
	Safety device	Temp sensor control system、Dry burning-resistant protection device、over temp protection system、water and electricity isolation system	
	Rear wash	0.4-0.6 L/min(water pressure \geq 0.15MPa)	
	Front wash	0.4-0.65 L/min(water pressure \geq 0.15MPa)	
	Strong wash	0.45 L/min(water pressure \geq 0.15MPa)	
Seat heating device	Seat temp control	Adjustable in 4 levels: Room temp, 33°C, 36°C, 39°C	
	Seat protective system	Temperature sensing control system/ fuse	
Warm air dryer	Warm air temperature	Adjustable in 4 levelsAdjustable in 4 levels: 35°C, 42°C, 48°C, 54°C (The wind temp is greatly affected by the environment, and the values are for reference only.)	
	Safety device	Temperature reset switch/fuse	
Deodorizer		Catalyst deodorant box	
Remote control		YES	

Cleaning Rate Test: In the seated state, turn the knob to the rear wash for more than 3 seconds to start the wide-width cleaning mode.

◆ Packing list ◆

Please check whether all the products are complete after you open the toilet box. The product packaging box should contain the following items:

- 1 x Smart toilet
- 1 x Manual
- 1 x Gasket
- 1 x Angle valve
- 1 Set of remote control (including remote control, bracket, double-sided tape, 2 AAA alkaline batteries)
- 1 x 9V alkaline battery (6LR61)

Warning

- This appliance is not intended for use by persons (including children) with reduced physical, sensory, or mental capabilities, or lack of experience and knowledge, unless they have been given supervision or instruction concerning the use of the appliance by a person responsible for their safety.
- Children should be supervised to ensure that they do not play with the appliance.
- If the supply cord is damaged, it must be replaced by the manufacturer, its service agent, or similarly qualified persons to avoid a hazard.



ONE YEAR LIMITED WARRANTY

BLOSSOM takes pride in the exceptional quality of its products, meticulously crafted with durable materials. We offer a one (1) year limited warranty that covers defects in materials or workmanship that are discovered during normal use. If any such defects are found, we will replace the parts or product at no charge to the original purchaser, subject to proof of purchase.

To ensure proper installation and avoid product failure, we recommend that all BLOSSOM products be installed by a licensed professional. It is important to understand that any damage or failure that arises from improper installation, misuse, or failure to engage a licensed professional is not the responsibility of BLOSSOM.

This limited warranty will be voided if:

- Installation recommendations are not followed.
- The product was moved from its original installation location.
- The product was modified from its original state.
- Improper maintenance, misuse, abuse, or damage occurs.

BLOSSOM holds no liability for any special, incidental, or consequential damages that may arise from the installation, replacement, return, or use of our products. Our warranty is explicitly defined and comprehensive, covering specific issues as outlined. Any matters that fall outside the scope of our warranty are not within our responsibility.

BLOSSOM
ALL RIGHTS RESERVED

www.BlossomUS.com