

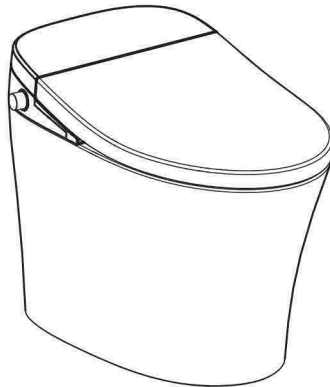

Thank you for choosing our products !



ST09 01

Smart Toilet Manual

Please read the manual carefully before installing and using.*

These photos are for reference only, please refer to the actual products!

Contents

Before use

Safety precautions	1
Overall sketch	6
Function introduction	7

Installation guide

Toilet installation	8
Remote control bracket installation	11

Operation

Operation introduction	12
Preparation	12
Product use	13
Troubleshooting	19
Cleaning and Maintenance	20



Appendix

Product specification	24
Packing list	25



Safety precautions



Please read the 'Safety Precautions' section carefully before use. All listed precautions are important for your safety and must be followed.

Sign and meaning

	Warning	Improper operation due to ignoring the instructions may result in death or injury.
	Notice	Improper operation due to ignoring the instructions may result in personal injury and property damage.

The following signs indicate important safety precautions.

Sign	meaning
	Represents 'not allowed' or 'forbidden'
	Represents 'enforced' or 'required'

 WARNING	
	<p>Do not touch the electrical outlet with wet hands.</p> <ul style="list-style-type: none"> • Doing so may cause electric shock.
	<p>Do not pour water, hot water, or detergent on the top of the toilet or electrical outlet.</p> <ul style="list-style-type: none"> • This may cause fire, electric shock, overheating, or short circuit. • It may also lead to injury and indoor water seepage due to damage to the product.
	<p>Never attempt to disassemble, repair, or alter the product yourself.</p> <ul style="list-style-type: none"> • Doing so may cause fire, electric shock, overheating, or short circuit.
	<p>Do not install the toilet in a car, ship, or any other moving object.</p> <ul style="list-style-type: none"> • This may result in fire, electric shock, short circuit, or malfunction. • The ceramic, seat, and main parts may also be damaged from falling.
	<p>Stop using the product if it malfunctions.</p> <ul style="list-style-type: none"> • Under the following conditions, disconnect the power supply and turn off the water angle valve: <ul style="list-style-type: none"> –Water leakage from the pipe or inside the product –Cracks or damage to the product –Unusual sounds or smells –Smoke –Unusual heating –Blockages –Falling out of the cushion • Continuing to use the toilet despite these faults may result in fire, electric shock, overheating, short circuit, injury, and indoor water seepage.



WARNING

Do not use seawater or any water other than tap water or potable well water (underground water).

- Doing so may cause skin irritation or damage to the product.

Do not touch the electrical plug during a thunderstorm.

- This may result in electric shock.

Do not allow the water inlet soft pipe to come into contact with the electrical plug or outlet.

- Moisture condensation may cause fire, electric shock, overheating, or short circuit.

Do not damage or destroy the power cable or plug.

- Avoid striking, yanking, twisting, excessively bending, or placing heavy objects on the cords. Do not bind or pinch the cords.

- Damaged cords can cause fire, electric shock, overheating, or short circuit.

Do not use a loose or faulty electrical outlet.

- This may result in fire or short circuit.

Use the electrical outlet and wiring according to specified guidelines.

- Incorrect use may cause fire due to improper appliance wiring.

Do not insert fingers or objects into the warm air outlet.

- Avoid placing objects or clothes on or covering the air outlet.
- This may cause burns, electric shock, or damage to the accessories.

Keep cigarettes and other open flames away from the product.

- This may cause a fire.



Pay Attention to Low-Temperature Scalding

- Improper use of the warm seat may cause low-temperature scalding.
- If sitting for an extended period, please turn the temperature setting to the "off" position. Set the seat temperature to "off" and the warm air dry temperature to "low" in the following situations:
 - For children and elderly individuals who cannot adjust the temperature themselves
 - For patients and disabled individuals who may have behavioral issues.
 - For people taking medications with sedative effects (e.g., hypnotics, cold remedies) or those who are intoxicated, overly tired, or drowsy.

This is an electrical product; do not install it in a location prone to moisture or high humidity.

- If installed in a bathroom, also install a ventilator to ensure proper ventilation.
- Failure to do so may cause fire or electric shock.

The product must be connected to a cold water supply.

- Failure to connect to the cold water supply may cause burns or product malfunction.

The product must be properly grounded.

- If not properly grounded, it may cause electric shock.
- Ensure that grounding resistance is below 100 ohms, the earth wire is at least 1.5 mm in cross-section, and made of copper.
- Please have a qualified installation company handle the grounding.





WARNING

Confirm Grounding of the Electrical Outlet

- Ensure the electrical outlet is properly grounded.
- Failure to do so may cause electric shock due to faults or short circuits.

The Power Outlet Must Follow These Rules:

- Failure to comply may result in fire or electric shock.
 - a. Use a high-sensitivity, fast-responding leakage switch (rated at 15mA or below) or an insulating transformer (1.5kVA-3kVA) to protect the outlet circuit.
 - b. Ensure the outlet installation location is away from the bathtub.
- Confirm that the above wiring guidelines (a and b) are completed, or have a qualified engineering contractor perform the installation.

Ensure the Electrical Plug is Firmly Inserted into the Outlet

- Failure to do so may cause fire, overheating, or short circuits.

When Removing the Plug, Hold the Plug Itself, Not the Wire

- Do not pull the plug by the wire.
- Pulling by the wire may cause damage, leading to fire or overheating.

If the Power Cord is Damaged, Have it Replaced by a Professional

- Contact the company's maintenance department or a similar service for replacement.
- This prevents potential hazards.

Turn Off the Power During Maintenance or Inspection

- Failure to do so may result in electric shock or damage to components.
- Note: This does not apply to nozzle cleaning.

Disabled Individuals or Those Lacking Experience (Including Children) Should be Supervised While Using This Product

- Supervision is required to prevent scalding, electric shock, fire, or injury.

Do Not Allow Children to Play with This Product

- Unsupervised use by children may cause scalding, electric shock, fire, or injury.

Do Not Dispose of Lighted Cigarettes or Flaming Materials in the Toilet

- Doing so may cause fire.

Do Not Use the Product if You Have a Pacemaker or Other Sensitive Medical Equipment

- The strong magnets inside the product may interfere with pacemakers and other medical devices.





NOTICE

Do Not Use the Product if it is Loose

- The toilet and seat may separate and fall, potentially causing injury.

Avoid Touching Broken Areas

- Touching broken parts may cause injury. Replace damaged parts as soon as possible.

Do Not Apply Force, Place Heavy Objects, or Stand on the Product

- Doing so may cause damage, falling, or injury.
- It could also result in indoor water seepage if the product is damaged.

Do Not Pull the Product by the Seat or Cover

- Do not open the seat or cover when objects are on the product.
- This could cause the main body to fall, leading to injury.

Use Only Neutral Kitchen Detergent for Cleaning Plastic Parts and the Water Inlet Hose

- Avoid using bathroom detergents, household cleaners, gasoline, banana oil, cleaning powders, or nylon brushes.
- Using inappropriate cleaners may damage the plastic parts, cause cracks, or result in injury due to malfunction.
- It could also lead to water leakage from a damaged hose.

To Prevent Sudden Water Leakage, Do Not Remove the Water Inlet Filter While the Angle Valve is Open

- Refer to the cleaning instructions for the water inlet filter.
- Removing the filter while the valve is open may cause water to spray out.

Do Not Crush or Bend the Water Inlet Hose

- Crushing or bending the hose may cause water leakage.

Use Only the New Hose Provided in the Accessory Box

- The old hose is not recyclable and may cause water leakage.

Do Not Pour Hot Water into the Toilet

- Pouring hot water may damage the toilet and cause injury or indoor water seepage.

Do Not Flush Large Amounts of Toilet Paper or Other Items Except Sewage and Small Amounts of Toilet Paper

- Flushing inappropriate items may cause damage to the toilet and result in injury or indoor water seepage.

Do Not Lean on the Toilet Cover While Using It

- Leaning on the cover may damage it.





NOTICE

Close the Angle Valve if Water is Leaking

- To prevent water damage, always close the angle valve if you notice any leaks.

Prevent Pipe or Hose Damage in Freezing Conditions

- When room temperature is below 0°C, adopt anti-freezing measures to prevent damage to pipes or soft hoses.
- Frozen water inlet hoses can damage the main body or piping, leading to water leakage.
- Ensure proper room temperature to avoid freezing.

Drain the Inlet Soft Hose and Cut the Power if Not in Use for an Extended Period

- Before leaving the product unused for a long time, drain the inlet soft hose and disconnect the power supply.
- When using the product again, open the angle valve and let water flow first.
- Failure to do so may cause skin irritation due to poor water quality.
- Keeping the power connected can lead to overheating or fire hazards.



Ensure the Filter is Properly Installed

- Confirm that the filter is screwed in tightly during installation.
- A loose filter may result in water leakage.

Address Blockages in the Toilet Drain Outlet Properly

- If the drain outlet is blocked, cut off the power before cleaning the obstruction.
- This will prevent sewage overflow and indoor water seepage caused by the auto flush function.
- Use professional tools available in the market to clear blockages.

Flush the Toilet After Urination

- Flushing after urination helps prevent difficulty in cleaning the toilet, drain blockages, or sewage overflow, which can lead to indoor water seepage.

Clean Spills on the Floor Promptly

- Use a dry towel to clean up urine, detergent, water, and other spills on the floor.
- This prevents dirt buildup or floor corrosion.



NOTICE

This bidet must be connected to a GFCI outlet and should not be used with an extension cord

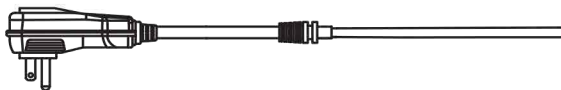

Overall Sketch

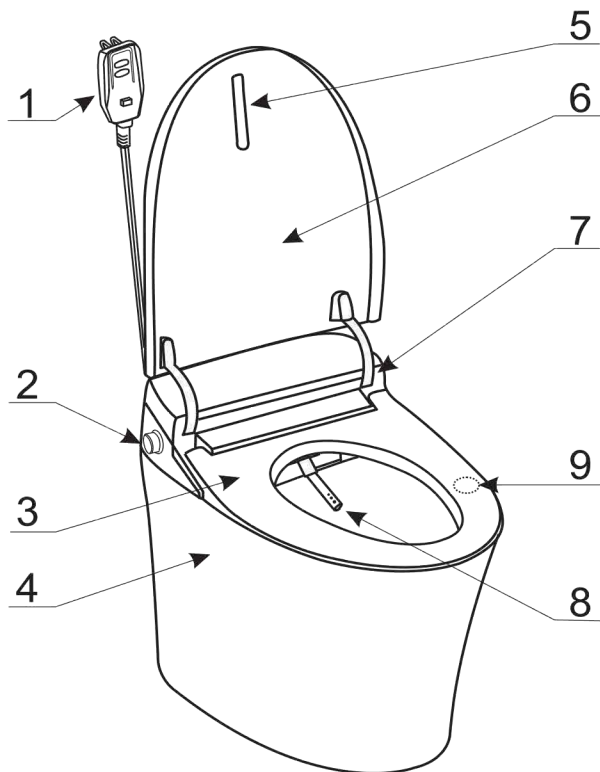

- | | |
|---|--|
| 1 | Power plug (Electric Leakage Protection) |
| 2 | Side knob |
| 3 | Heated seat |
| 4 | Toilet bowl |
| 5 | Cushion pad |
| 6 | Toilet lid |
| 7 | Damper |
| 8 | Nozzle |
| 9 | Sensing area |

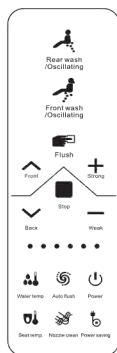

Remote control

NOTICE

The contents of this manual, including but not limited to product materials, processes, and functional characteristics, may differ from the actual product due to process improvements or product upgrades. Please refer to the actual product for the most accurate information.

Functions introductions

Function	Introduction
Rear Wash	Cleans the rear with a back-and-forth nozzle movement
Rear Oscillating Wash	Provides rear cleansing with an oscillating nozzle
Front Wash	Delivers a gentle front spray
Front Oscillating Wash	Cleans front with an oscillating nozzle
Nozzle Position Adjustment	Adjusts nozzle position for optimal washing
Temperature Adjustment	Sets seat and water temperature
Water Pressure Adjustment	Controls cleaning water pressure
Seat Sensor	Activates functions when sitting
Nozzle Self-Clean	Automatically cleans the nozzle
Smart Remote Control	Operates functions via remote
Energy Saving	Reduce electricity usage
Soft Close	Gently closes the seat and cover
Auto Flush	Flushing activates automatically after use
Power Switch	Turns the power on and off
Blackout flush	Flushes by pushing a side button when power is off
Ceramic Bowl Pre-Wet	Pre-wets the bowl before use
Foot Touch Flush	Activates flushing by touching the sensor switch with your foot
Knob Operation	Controls the machine with a knob
Dual Flush	Offers two flushing modes with different water volumes

Installation method

◆ Toilet installation ◆

※ Supply stop installation

1. Turn on the water supply and flush for 1 minute. This removes any debris that might damage the toilet.
2. Turn off the water supply and remove the old supply stop.
3. Wrap sealing tape around the end of the water supply pipe (1/2" NPT male thread) This ensures a proper seal. Screw the adapter onto the pipe, aligning it with the arrow as shown.
4. Apply Teflon tape to the fitting. Start wrapping at the end of the fitting to prevent seizing. Tighten the threaded joint 1-2 turns beyond finger tight, being careful not to over-tighten.

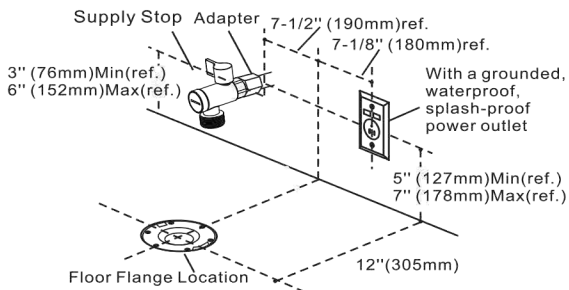
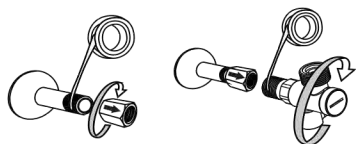

※ Confirm water flow

1. Install a matching hose.
 - Direct the hose to a bucket with a capacity of 3 gallons (11.4L) or more. If a matching hose is unavailable, cover the supply stop outlet with a cloth and place the bucket under the valve.
2. Turn on the supply stop
 - Ensure that at least 1 gallon of water flows out within 10 seconds.
3. If water pressure is low,
 - Remove the flow regulator from the supply stop or use a booster pump to increase the pressure.
4. Close the supply stop
 - Remove the installed hose.

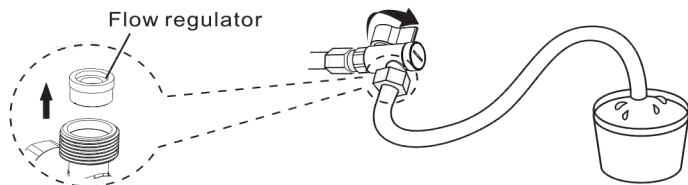

※ Install the toilet

1

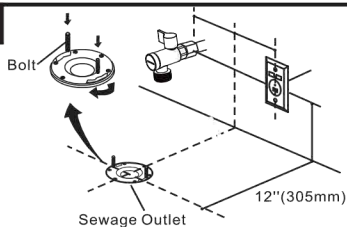

For new installations, toilet flanges must be installed. Install flange bolts accordingly

2

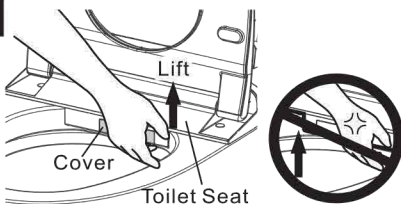

Lift the toilet seat-lid assembly from the interior, back right, being careful not to pull excessively

3

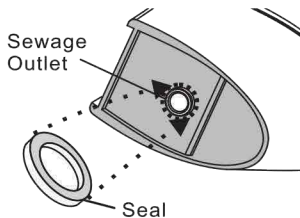

Install a sealing ring under the toilet.

4

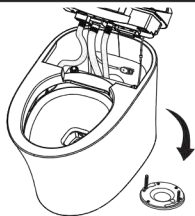

Install the toilet onto the flange, ensuring the bolts align with the holes in the toilet. (From the top)

5

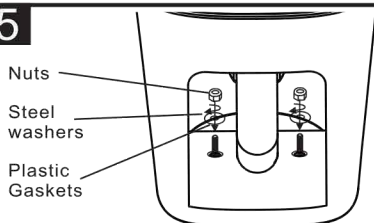

Use a wrench to tighten the nuts and other accessories onto the fixing bolts. (From the top)

6

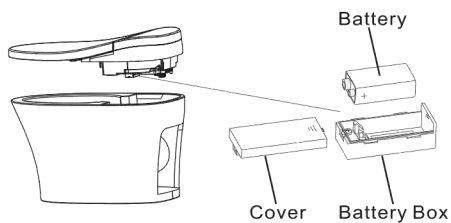

1. Carefully remove the battery case cover.
2. Install the battery and slide the cover back onto the battery box.
3. Press the control dial on the side to ensure normal flushing operation.

Note:

- Use alkaline batteries.
- The battery maintains the flushing function during a power failure.
- Do not dispose of used batteries in the trash; please recycle them at your local battery collection center.

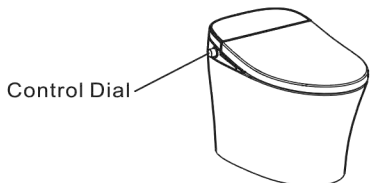

7

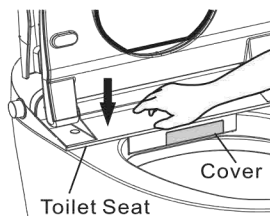

Reinstall the toilet seat-lid assembly to complete the installation.

Note: Avoid applying excessive force when reattaching the assembly.

※ Connect the water inlet pipe

Connect the water inlet hose to the supply stop.

Note:

1. Tighten by hand, then turn the nut 1/4 turn with a wrench.
2. Open the supply stop.
3. Check for leaks.
4. Apply silicone sealant around the base of the toilet and allow it to dry for 24 hours.

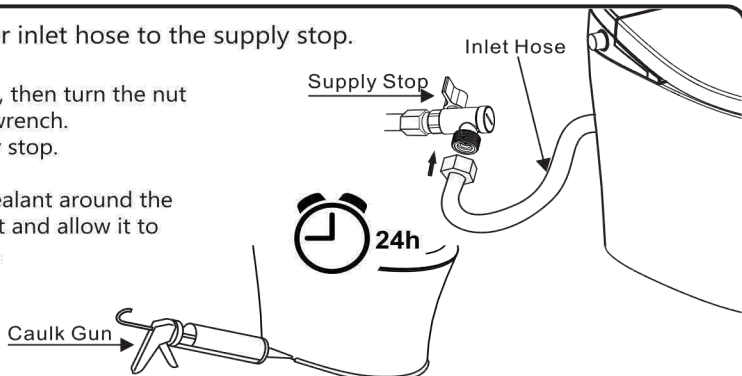

◆ Install the remote controller ◆

■ The following picture shows the installation method

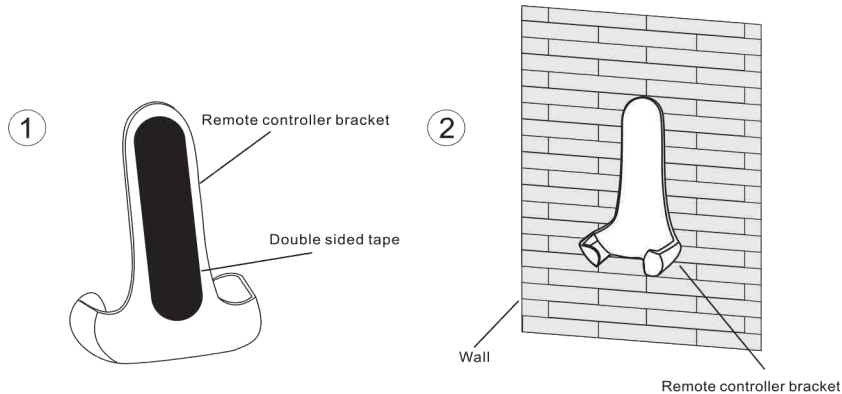

Tear off the paper from the double-sided tape on the back of the bracket and stick the bracket onto the wall.

Notice: Clean the installation area before applying. Press the tape firmly and evenly. Wait 15 minutes before use.

Operation

◆ Operation introduction

- * The design of this product is primarily controlled by remote control, with additional support from a side knob control.
- * The following section provides a functional introduction.

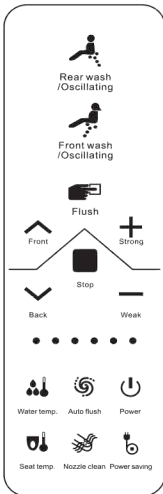

Rear wash / Oscillating

Front wash / Oscillating

Flush

Front + Strong

Stop

Back Weak

Water temp. Auto flush Power

Seat temp. Nozzle clean Power saving

Remote control

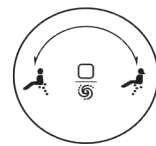

Side knob

* Indicator lights and LED display panels may vary according to specific model configurations; please refer to the actual model for details

◆ Preparation

1. Open the angle valve

Switch to this position

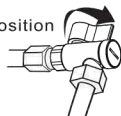

2. Confirm power plug is well plugged into the electric outlet and the indicator light is on.

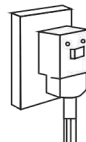

3. After the machine is powered on and initialized, it defaults to the last used settings. Parameters such as water temperature, seat temperature, auto deodorization, and auto flushing are automatically restored to their settings before power was turned off.

4. If it is not powered on, press the side knob to power it on.

◆ How to use

Sit on the seat

- The seat sensor reacts automatically when you sit on it.
- Water is released to pre-wet the inner ceramic bowl.

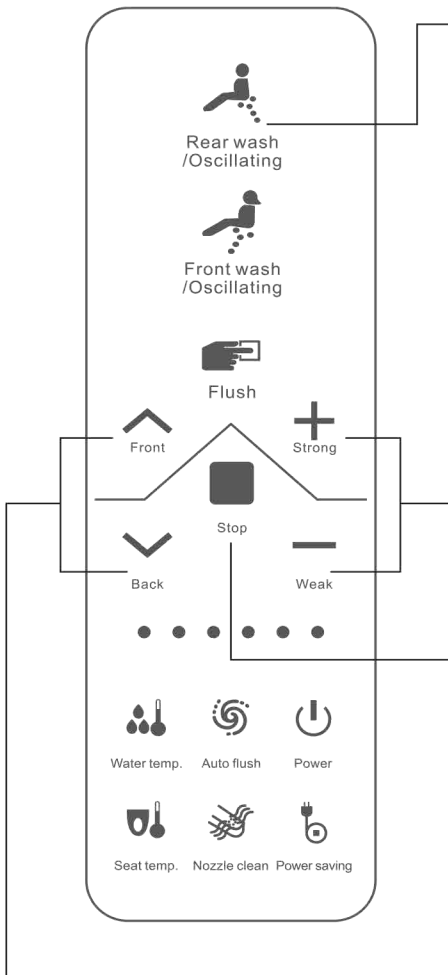

Rear Wash/Oscillating

Press this button to extend the nozzle for operation. Press again to switch to rear oscillating cleansing, where the nozzle swings back and forth. Press once more to stop oscillating cleansing and return to rear wash.

Water Pressure Adjustment

Choose from 4 levels of water pressure by pressing these buttons for comfortable cleansing.

Stop

Press this button to stop the current cleaning operation. Rear washing/ front washing will stop automatically after 2 minutes if this button is not pressed.

Nozzle Position Adjustment

Adjust the nozzle to 5 positions for a comfortable cleaning position by pressing these buttons. Note: Nozzle position adjustment is unavailable during oscillating cleaning.

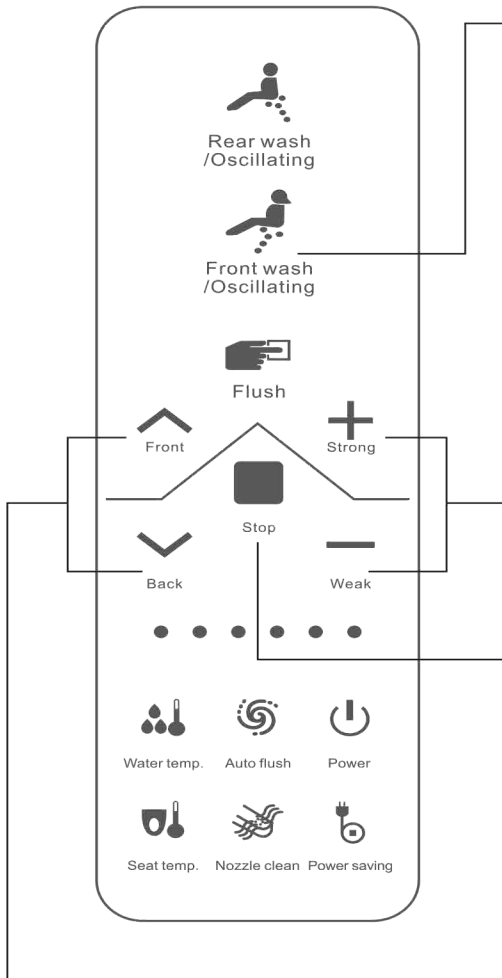

Front Wash/Oscillating

Press this button to extend the nozzle for operation. Press again to switch to front oscillating cleansing, where the nozzle swings back and forth. Press once more to stop oscillating cleansing and return to front wash.

Water Pressure Adjustment

Choose from 4 levels of water pressure by pressing these buttons for comfortable cleansing.

Stop

Press this button to stop the current cleaning operation. Rear washing/ front washing will stop automatically after 2 minutes if this button is not pressed.

Nozzle Position Adjustment

Adjust the nozzle to 5 positions for a comfortable cleaning position by pressing these buttons. Note: Nozzle position adjustment is unavailable during oscillating cleaning.

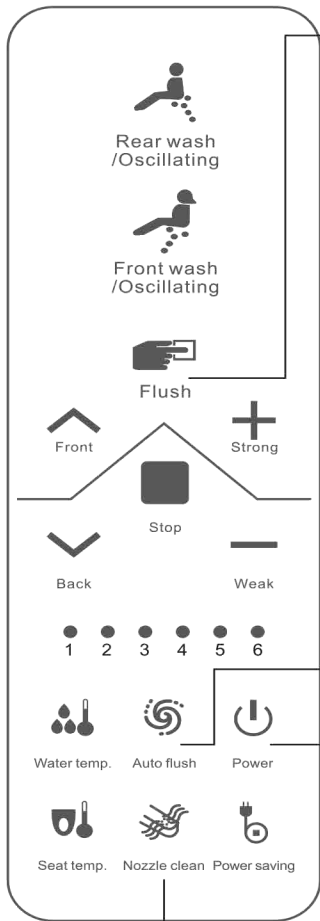

Flush

Press this button to flush the toilet once.

Auto Flush

Press this button to turn on/off the auto flush function. Indicator light no. 5 will turn on/off simultaneously. When auto flush is on, the toilet flushes automatically 5 seconds after the person leaves the seat. Note: If a person uses the remote control/knob to flush the toilet while seated, auto flush will not activate after they leave the seat.

Power

Press this button to turn the machine on/off.

Nozzle Clean

In standby mode, press this button to initiate nozzle cleaning. The nozzle extends and water flows. You can use a brush to clean. Cleaning ends after 1 minute or when the "stop" button is pressed. Note: Nozzle cleaning is effective when the seat is not occupied. The nozzle also cleans automatically around it during rear wash/front wash operations.

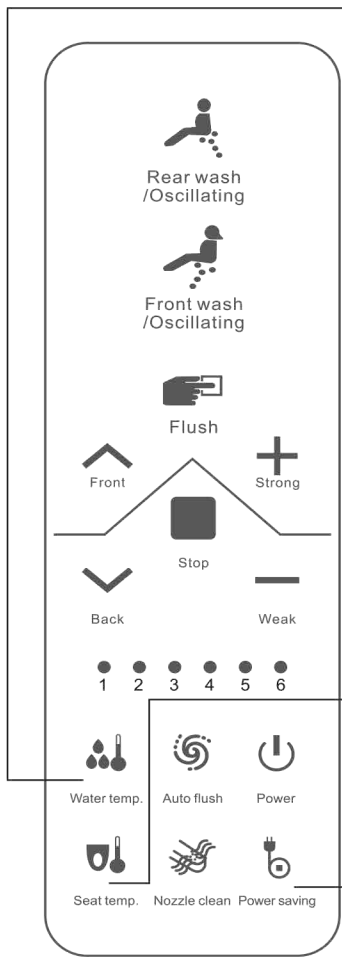

Water Temperature Adjustment

Press this button to adjust water temperature. There are 4 levels: default is 36°C when the machine is turned on. Each press changes the temperature: 36°C → 39°C → 36°C → 33°C → normal temperature → 33°C → 36°C.

Seat Temperature Adjustment

Press this button to adjust seat temperature. There are 4 levels: default is 36°C when the machine is turned on. Each press changes the temperature: 36°C → 39°C → 36°C → 33°C → normal temperature → 33°C → 36°C.

Note: To prevent low temperature discomfort, seat temperature automatically reduces to 33°C after sitting for 10 minutes.

Power Saving

Press this button to turn on/off automatic power saving. Indicator light no. 3 will turn on/off simultaneously. When automatic power saving is on, the machine enters power saving mode 1.5 minutes after the seat is vacated.

Product side knob

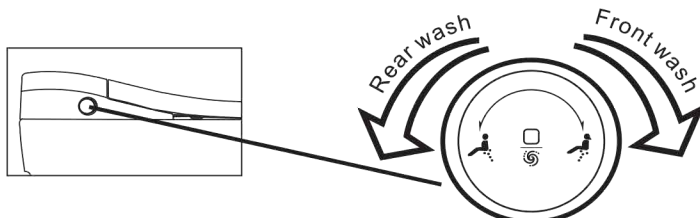

When Seated:

- Rotate the knob forward to extend the nozzle for front wash.
- Rotate the knob forward again for oscillating front wash (nozzle moves back and forth). Rotate the knob forward to switch between regular front wash and oscillating front wash.
- Rotate the knob back to extend the nozzle for rear wash.
- Rotate the knob back again for oscillating rear wash (nozzle moves back and forth). Rotate the knob back to switch between regular rear wash and oscillating rear wash.
- When using rear or front wash, press the knob to stop the wash.

When Leaving Your Seat:

- Turn the knob forward or back and hold for 3 seconds to initiate nozzle cleaning. The nozzle extends and is cleaned with running water. You can use a brush for cleaning at this time.
- Adjust seat temperature by turning the knob forward or backward. Switch between normal temperature and 36°C.
- Press and hold for 3 seconds to turn off the machine.

When Shut Down:

- Turning the knob forward, backward, or pressing it will turn the machine on.

When in Standby:

- Press the knob once to start a large water flush.
- Double-click the knob twice to start a small water flush.

Remote control code matching

If a user has more than two items of the same brand of smart toilet, there may be interference when using the remote control. In this case, use the remote control code matching function to ensure each remote control is unique to its toilet.

Follow these steps:

1. Unplug the smart toilet from power.
2. Simultaneously press the "weak" and "back" buttons until the indicator light blinks continuously.
3. Plug the smart toilet back in within 5 seconds.
4. The remote control indicator light will stop blinking when the code matching is complete.

Notice: The remote control matching process times out after 10 seconds and will stop automatically if it exceeds this time

Buzzer

Buzzer:

- **Buzz once:** Seat occupied; all functions available.
- **Buzz twice:** Seat vacant; some functions available.
- **Buzz three times or more:** Product fault.

Reminder: The buzzer operates only during remote controller or side button operations or during initialization.

Foot touch flush

Operating Instructions:

- Activating the sensor switch at the bottom with your foot activates the flushing function.

Reminder:

This function does not operate when seated.



◆ Troubleshooting ◆

SITUATION	REASON	PROCESS
No power	The electrical outlet is not connect to power supply or the plug is not insert to the bottom	Check if the electrical outlet is connected to the power supply; press the reset key on the plug
No water comes out while cleaning	Low water pressure	Raise the water pressure
	Water inlet filter is blocked	Remount and clean the filter according to the instructions
Cleansing water in not warm enough	Water temp setting is incorrect	Readjust the setting
Seat does not heat	Seat temp setting is incorrect or the product is in power saving mode	Readjust the setting
Seat and cover are loose	Fixed bolts are loose	Tighten the bolts
Remote controller failure	Battery is dead	Replace the battery
No response when pressing the key	Key malfunction	Reboot or contact customer support
Water leakage	Shutoff valve, water supply hose and water separator are not well connected	Reconnect them

Cleaning and Maintenance

• Toilet bowl cleaning

- Before cleaning, ensure the electrical plug is removed.
- Use a damp soft cloth to wipe the toilet shelf and seat.
- Clean dirt promptly; for stubborn stains, use a neutral detergent if necessary.

• Nozzle Cleaning and Maintenance

Press "nozzle clean" to extend the nozzle for automatic washing, then use a brush to clean it.

Attention: Do not use a steel brush for cleaning.

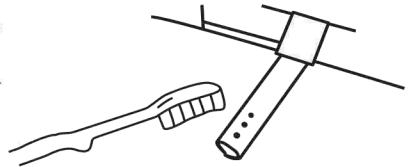

• Cleaning the filter

When the water pressure is too low or insufficient, please clean the filter.

1 Close the angle valve and stop water supply

Notice: Do not remove the filter without closing the angle valve.
----Otherwise water will spray out.

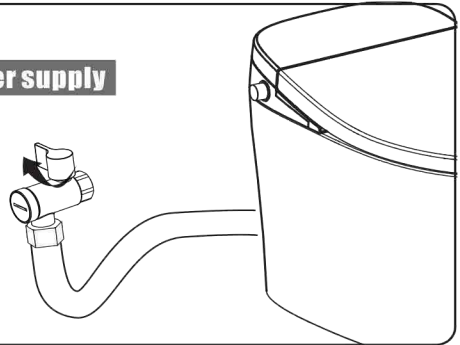

2

Remove the filter

Unscrew the cover of the filter by straight screwdriver and then pull out the cover as below:

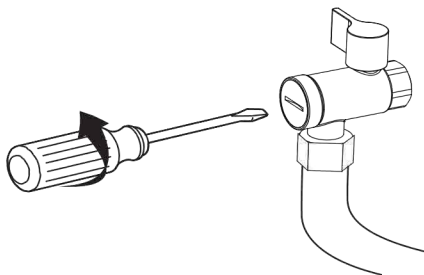

3

Clean the filter

- Remove the filter and clean it thoroughly.
- Flush off dirt or clean the filter using a toothbrush.

Note: Do not use any cleaning agents; clean with water only.
Avoid crushing the filter to prevent distortion.

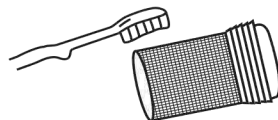

4

Reattach the filter

Reinstall the filter following the removal sequence.

Notice: Open the shutoff valve after installation and ensure there is no water leakage.

● Replace the remote control battery

When the battery is low, the remote controller may become insensitive or malfunction. Replace the battery at this point..

※ Attention

- Ensure the battery's positive and negative poles are correctly aligned; the compression spring should protrude from the negative pole.
- Do not mix new and old batteries;
- Please use alkaline batteries.

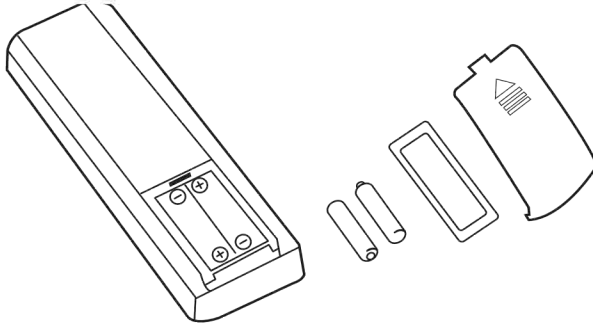

• Replace back up battery

Steps:

1. Pull out the power plug.
2. Lift the toilet seat lid.
3. Remove the battery cover.
4. Insert the battery in the correct position.
5. Press the flush button to ensure it functions properly.
6. Replace the cover and secure the toilet seat lid.

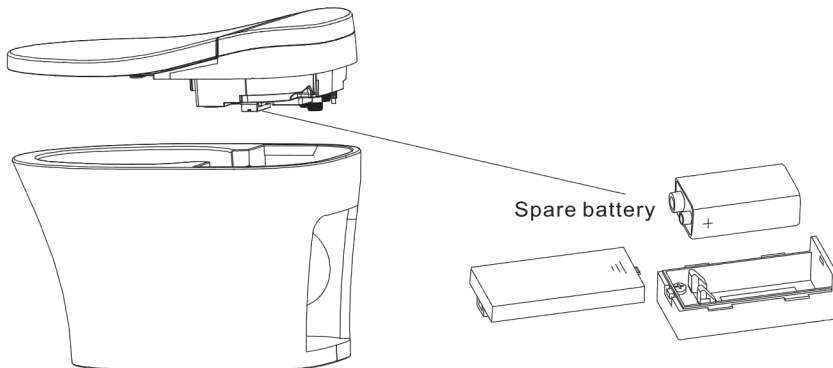

※ Notice

1. The backup battery must be a 9V alkaline battery; do not use carbon or other types.
2. Low battery or improper installation may cause abnormal flushing, including malfunction during power outage.
3. We recommend checking and replacing the backup battery every two years.
4. Please replace used batteries and recycle them properly.

◆ Product specification ◆

Ambient temp range		4°C-40°C	
Inlet water temp range		5°C-35°C	
Rated voltage		120V~ 60Hz	(Inlet water temp: 15°C±0.5°C)
Rated power		1200W	
Power cord length		0.85m	
Cleansing device	Water pressure range	0.14MPa-0.75MPa(Flow volume is no less than 18L/min)	
	Water pressure adjustment	Adjustable in 4 levels	
	Water temp adjustment	Adjustable in 4 levels: Room temp, 33°C, 36°C, 39°C	
	Safety device	Temp sensor control system、Dry burning-resistant protection device、over temp protection system、water and electricity isolation system	
	Rear wash	0.4-0.6 L/min(water pressure≥0.15MPa)	
	Front wash	0.4-0.65 L/min(water pressure≥0.15MPa)	
Seat heating device	Seat temp control	4 levels: Room temp, 33°C, 36°C, 39°C	
	Seat protective system	Temperature sensing control system/ fuse	
Remote control		YES	

Cleaning rate test: In the seated state, the knob is turned to the rear wash for more than 3 seconds to start the wide-width cleaning mode.

◆ Packing list ◆

Dear user

Please check whether the products are complete after you open the box of toilet. Product packaging box containing the items are:

1 Smart toilet



1 Manual



1 Angle valve (15/16" adapter, 1/2" adapter)



1 9V alkaline battery (6LR61)



1 Wax ring



1 Floor flange (with 1 bag installation bolt)



1 Set remote control (Including remote control, bracket, double side tape,
2 AAA alkaline batteries)



Warning

- This appliance is not intended for use by persons (including children) with reduced physical, sensory, or mental capabilities, or lack of experience and knowledge, unless they have been given supervision or instruction concerning the use of the appliance by a person responsible for their safety.
- Children should be supervised to ensure that they do not play with the appliance.
- If the supply cord is damaged, it must be replaced by the manufacturer, its service agent, or similarly qualified persons to avoid a hazard.



ONE YEAR LIMITED WARRANTY

BLOSSOM takes pride in the exceptional quality of its products, meticulously crafted with durable materials. We offer a one (1) year limited warranty that covers defects in materials or workmanship that are discovered during normal use. If any such defects are found, we will replace the parts or product at no charge to the original purchaser, subject to proof of purchase.

To ensure proper installation and avoid product failure, we recommend that all BLOSSOM products be installed by a licensed professional. It is important to understand that any damage or failure that arises from improper installation, misuse, or failure to engage a licensed professional is not the responsibility of BLOSSOM.

This limited warranty will be voided if:

- Installation recommendations are not followed.
- The product was moved from its original installation location.
- The product was modified from its original state.
- Improper maintenance, misuse, abuse, or damage occurs.

BLOSSOM holds no liability for any special, incidental, or consequential damages that may arise from the installation, replacement, return, or use of our products. Our warranty is explicitly defined and comprehensive, covering specific issues as outlined. Any matters that fall outside the scope of our warranty are not within our responsibility.

BLOSSOM
ALL RIGHTS RESERVED

www.BlossomUS.com